

Style A	Style B	Style C
		
Style D	Style E	Style F
		

Additional Information	
Filler, Drain (black circle)	Rc3/8
Level (white circle)	Φ30
Rough Product Weight	100kg
Rough Lubricating Oil Capacity	6.0 Liters
Mounting Tapped Holes	Machining the specified faces upon request

RI/RO-152F

Mounting Examples of Optional Parts

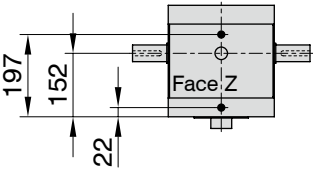
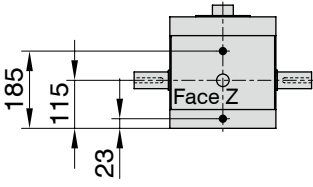
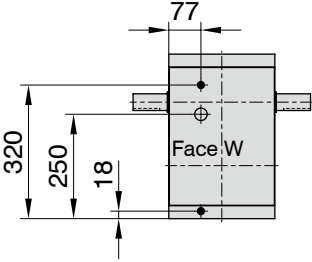
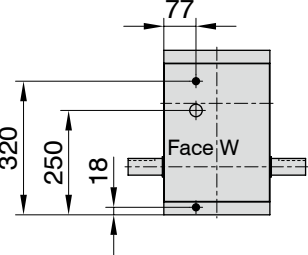
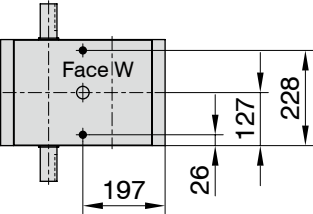
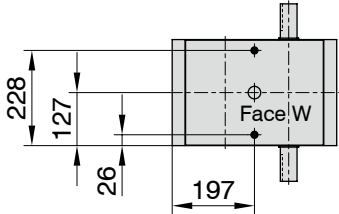
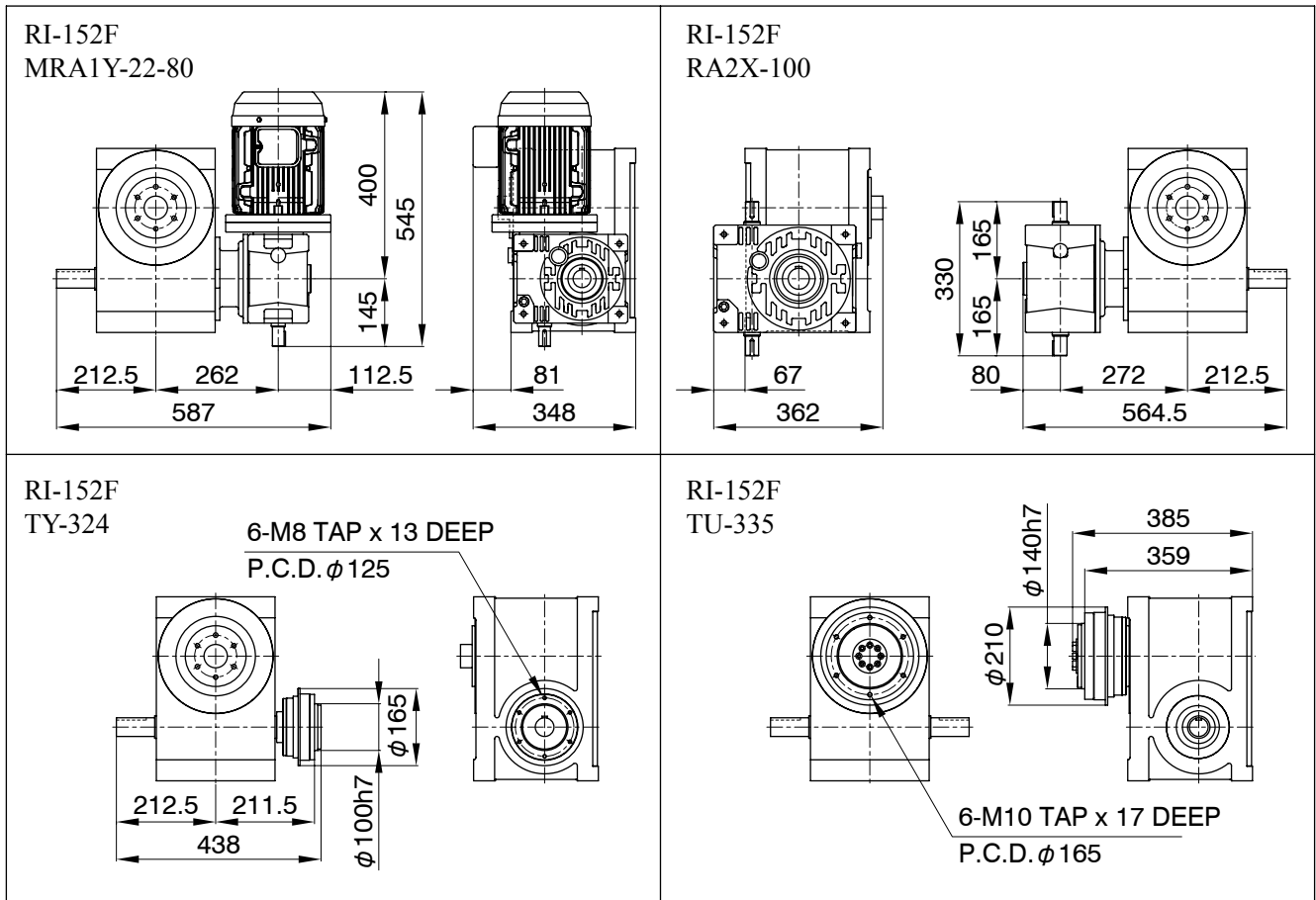

Additional Notes

- MA series worm reducer MAO63, 80 and 100 can be mounted.
- Mounting positions of a drive unit is standardized as 16 different pattern.
- MYTORQ torque limiter 300 series can be mounted.
- Autoflex couplings can be mounted.
- Autogard torquelimiter 400 series or Autoflex couplings can be mounted on the input shafts of a worm reducer.